



# DEGER S100-CF-DR

---

DATA SHEET

## WE ARE AT YOUR SERVICE WORLDWIDE



\* Sample Projects

## Single-Axis Tracking System

Single-axis, active tracking systems from DEGER enable the optimal utilization of all the irradiation energy, suitable for all widely-sold solar modules. With the patented sensor-based MLD technology you can achieve yield increases of approx. 28.1% for all photovoltaic applications. An easy plug-and-play installation is realized by means of the stable supporting construction. The decentralized control enables maximum independence. DEGER systems are “designed in Germany”- and stand for quality and durability.

## Rating chart using a sunny summer day as an example

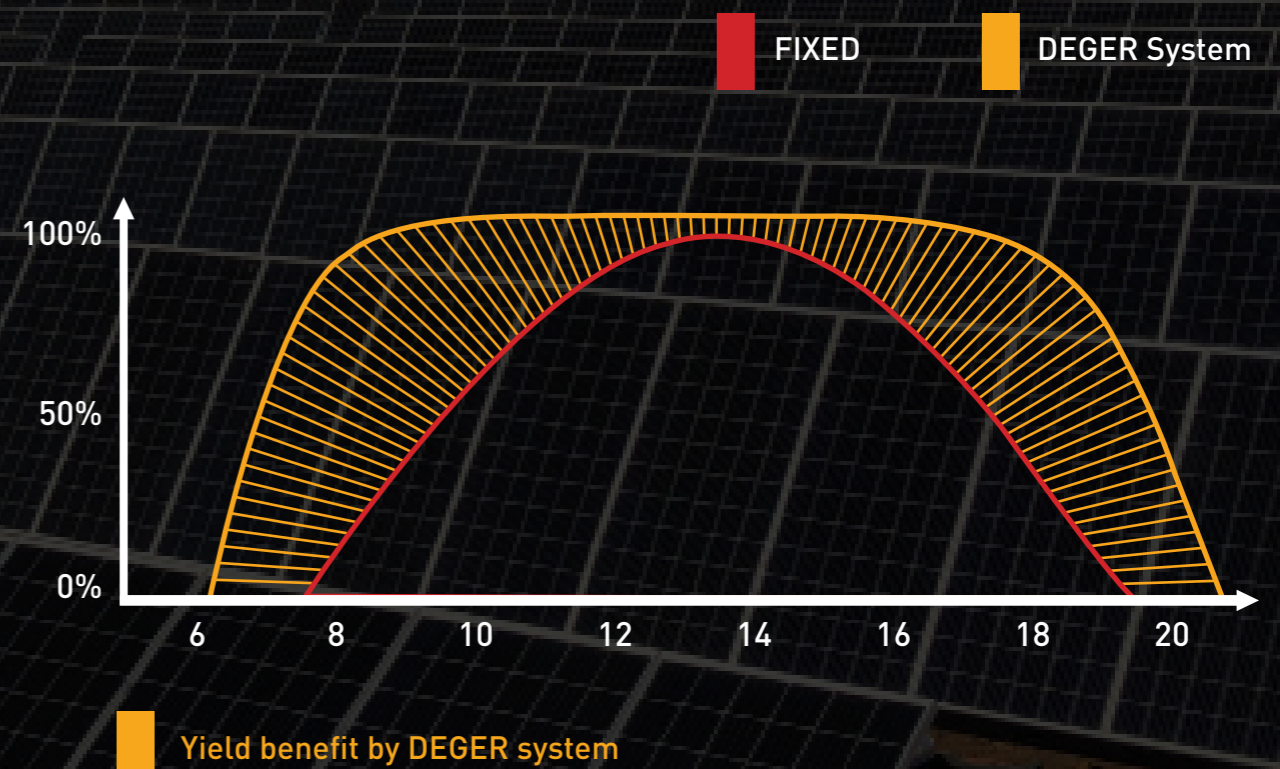

## ADVANTAGES



Module carrier profiles made from aluminum

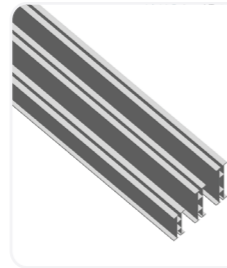

Availability of aluminum module carrier profiles in three different of heights: 65mm, 85mm and 100mm.



Hot dipped galvanized steel



Wind speed stability for up to 110 km/h



Non-linked rows



Low power consumption

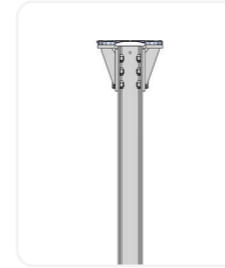

Usage of IPE and HEA ramming profiles. Roll forming profiles are not used on any DEGER trackers.



Robust and reliable tracking systems with heavy duty dampers

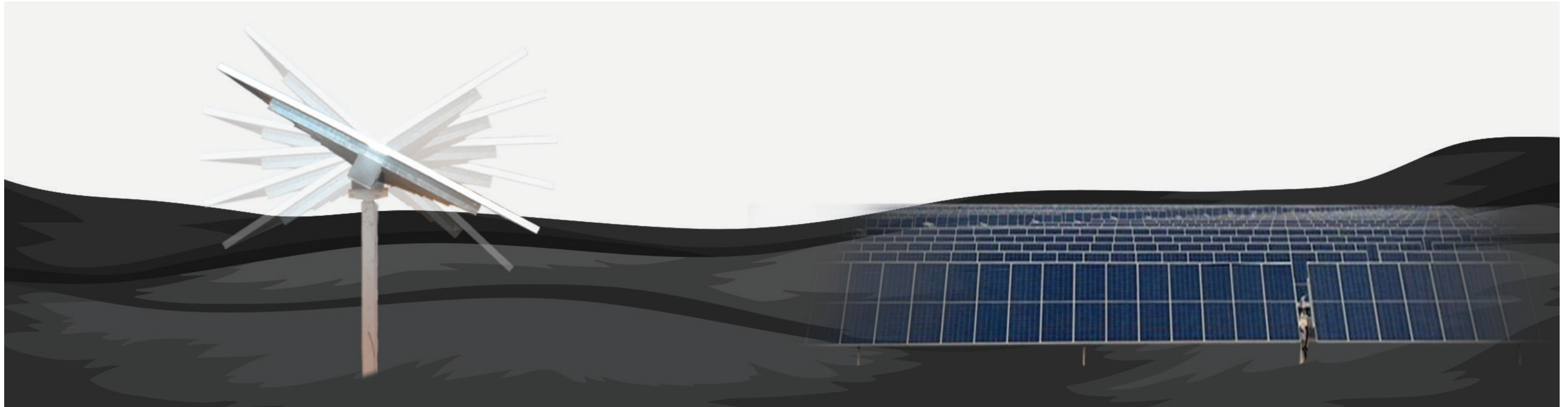

Fast and simple plug-and-play installation



High functional reliability and low-maintenance operation



Fewer electronic parts required thanks to the management of two trackers by one EKS1 control panel.



Tracking systems with 81,4 m<sup>2</sup> modul surface area.

# TECHNOLOGY

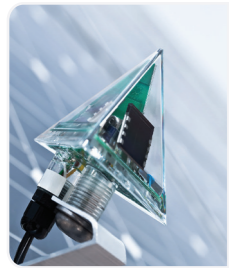

Intelligent Maximum Light Detection (MLD) system, up to 28.1 % yield increase with MLD technology.



Automatic reset to sunrise position overnight



Yield increase with snow sensor



Possibility of data collection every single second



Adjustable tracking system movement positions



Different cleaning positions



Adjustable wind speed limit for each solar tracking system (maximum 12 m/s)



Possibility of setting sunrise and sunset angles for shadow management via DEGER CTC software



Movement and wind/snow alarm data saved via Microsoft Excel



Possibility of individual tracking system management via DEGER CTC software

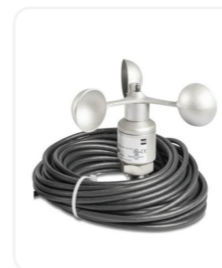

Wind protection with anemometer



Gearbox and DC motor technology

## MLD Technology

- Intelligent Maximum Light Detection (MLD) system, up to 28.1 % yield increase with MLD technology.

Technology that is proactive gets more out of the sun. The light irradiation's intensity is influenced by a number of factors – primarily clouds, of course. That is why it is crucial that a smart control is able to react to the conditions accordingly. The MLD principle takes on that task.

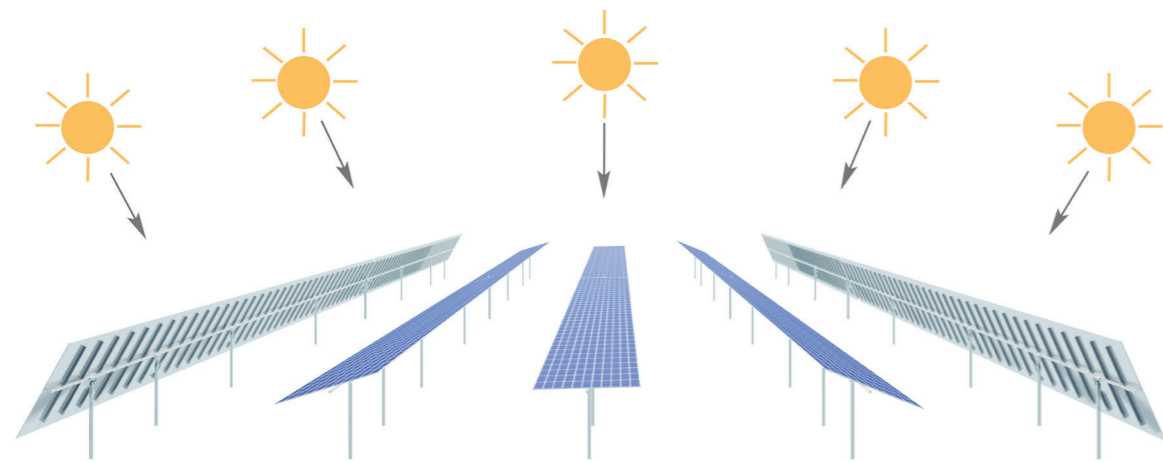

Sunshine: The DEGER system directly faces the sun all day.

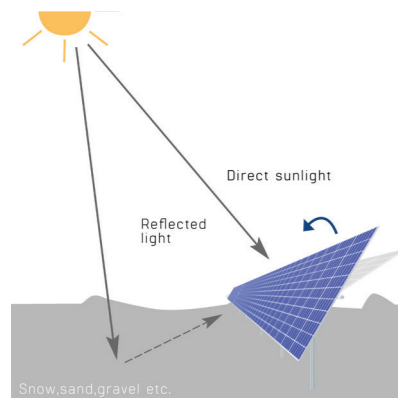

**Reflecting surface:**  
The DEGER system uses direct solar irradiation as well as energy from reflected light.

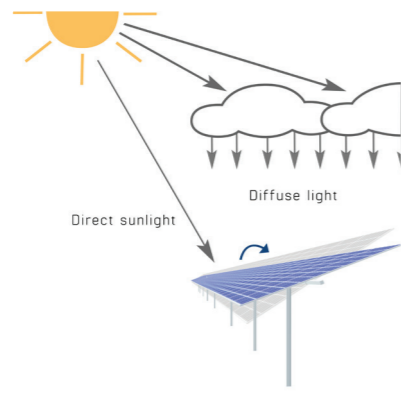

**Partly clouded:**  
In addition to the direct solar irradiation diffused light is also used to maximize the effect.

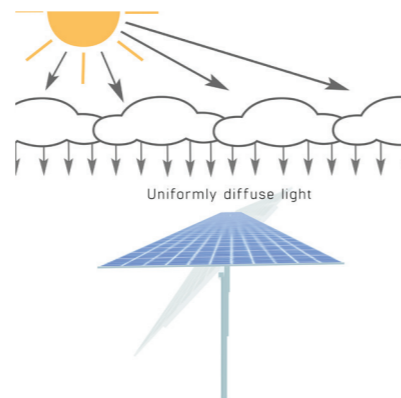

**Overcast sky:**  
The DEGER system catches all the diffused light by moving to horizontal position.

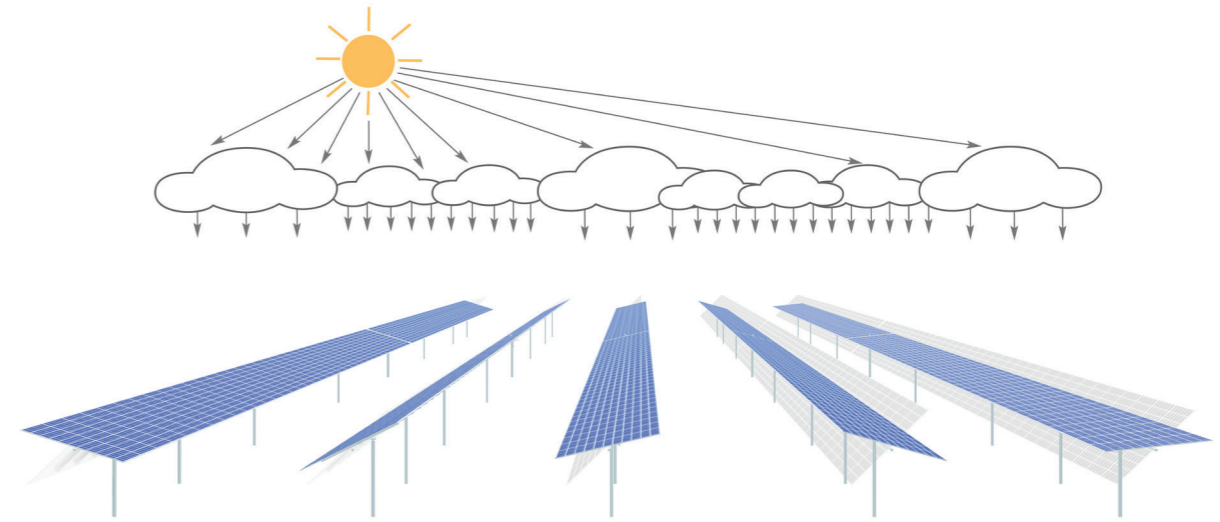

### Varying light conditions:

Because of different levels of cloudiness, the light conditions in solar park vary for each DEGER tracker. The individual control makes sure every DEGER system is optimally oriented to the brightest source of irradiation. This guarantees the highest energy yield possible.



The MLD-Sensor – the critical component in the MLD principle of controlling tracking systems.

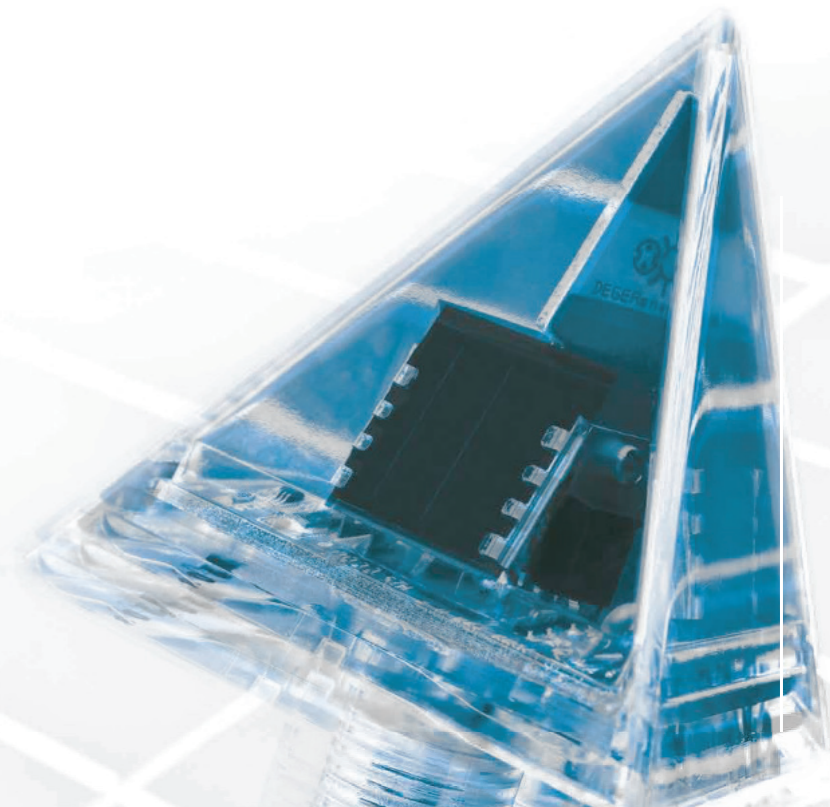

## Technical Specification

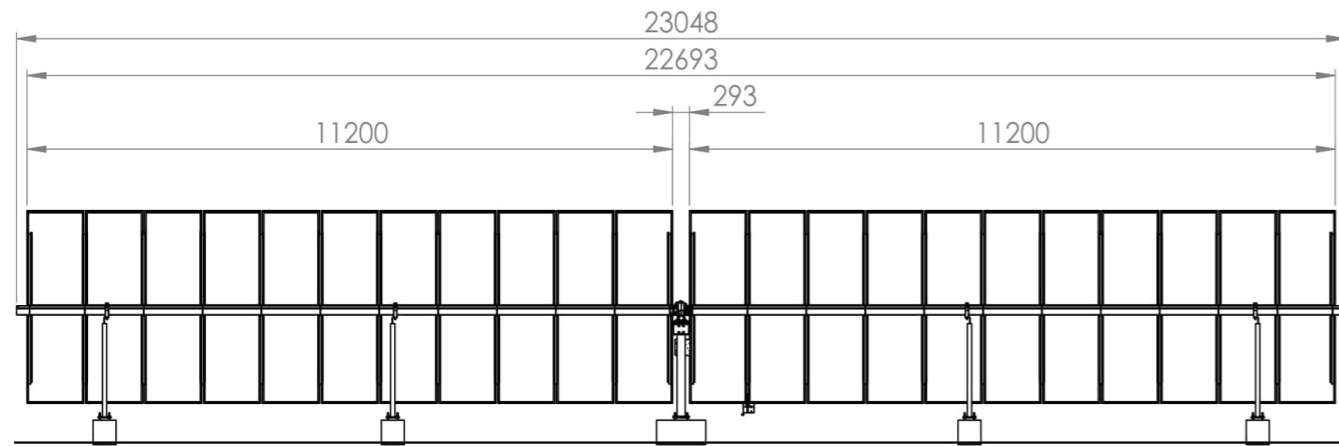

DEGER S100-CF-DR  
With Concrete Foundation<sup>(1)</sup>

### BASIC DATA

Nominal output (depending on module)	Up to 18.000 Wp DC
Tracking type	1-axis
Module surface (max.)	81,4 m <sup>2</sup>
Weight (total solar module weight)	Up to 1.180,3 kg
Approvals	CE, UL, CSA

### STRUCTURE

Materials	Hot-Dip galvanized steel, aluminum, synthetics
Galvanization	EN ISO 1461 or comparable
Bond-Type	Bolted connection, no welding on site
Certified statics	Yes

### DRIVE

Principle	Rotary drive
East-West angle	+50° / -50°
Spin speed	18°/min.
Sound level (without load)	At a distance of 10 Meters: 20-40 Db(A)
Protection class	IP 67

### ELECTRONICS & CONTROL

Operating voltage	100 - 240 V AC / 100 - 380 V DC / 50 - 60 Hz
Rated input current	0.8 A
Control	MLD-Technology
Protection class	IP 67

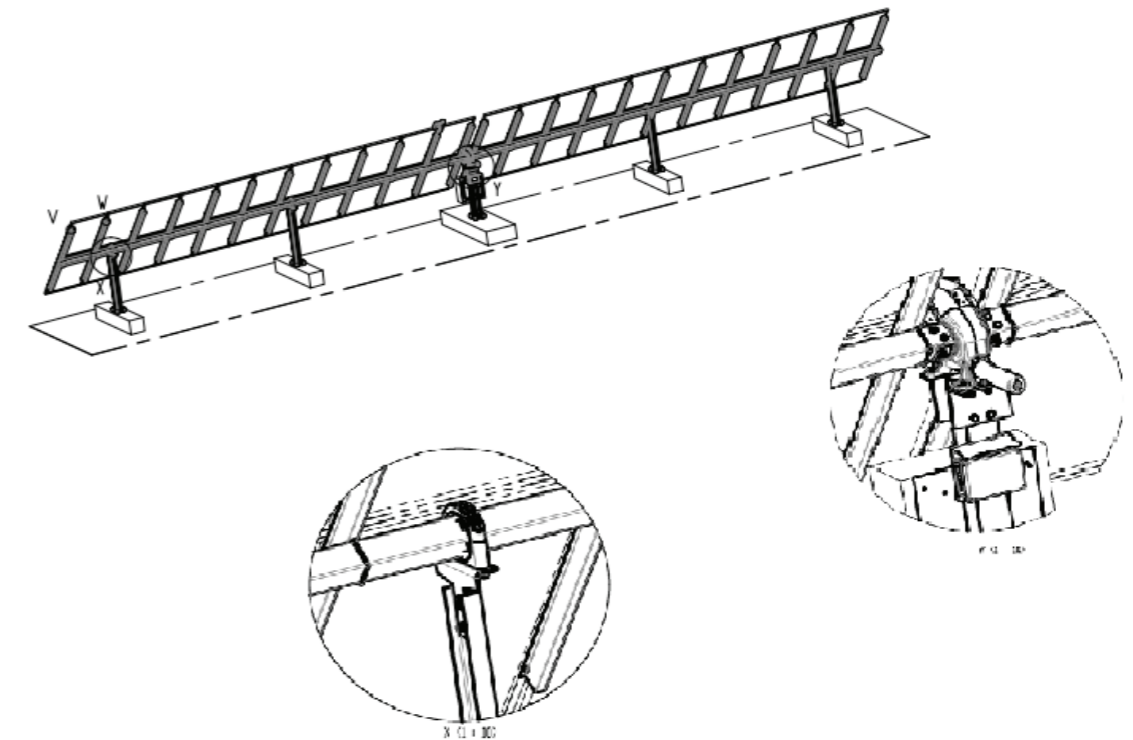

## Technical Specification

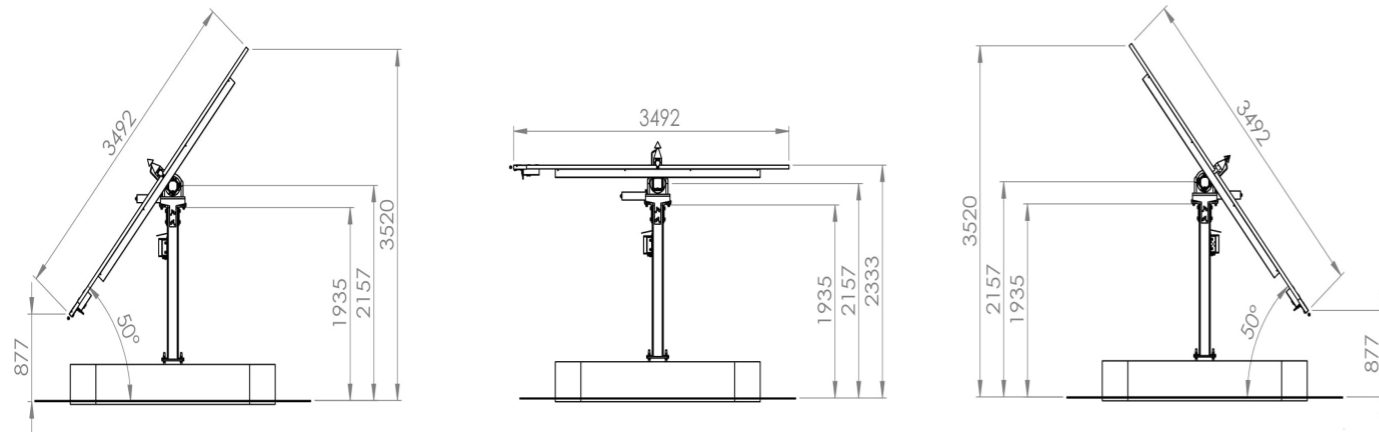

DEGER S100-CF-DR  
With Concrete Foundation<sup>(1)</sup>

### POWER CONSUMPTION (APPROX)

Control mode	1 W
With running actuator	50 W – 240 W
Internal consumption per year	5 kWh

### POWER OUTPUT

Output voltage	24 V DC
Output current (max.)	2.5 A

### CLIMATIC CONDITIONS

Installation over sea level	max. 2000 m
Permissible ambient temperature	-20°C – +50°C
Humidity range	5% – 95%
Permitted wind speed	Up to 110 km/h <sup>(2)</sup>

### GROUND CONDITIONS

Max. ground inclination East-West	10°
Max. ground inclination North-South	10° <sup>(3)</sup>
Subsoil requirements	Soil survey necessary

### PILE DRIVING FLEXIBILITY

Ramming accuracy related to axis	max. +/- 20 mm
Axis twist angle	max. +/- 5°
Ramming accuracy in height	max. + / - 10 mm

<sup>(1)</sup> Pictured dimensions can change depending on the module size and/or number of modules per tracking system

<sup>(2)</sup> With full occupancy – Laid out with Planning Tool

<sup>(3)</sup> Tracker axis installed parallel to the ground

### SCOPE OF DELIVERY

Complete single-axis tracking systems, solar module carrier system made of steel or aluminium - matching the module type used, patented MLD control (Maximum Light Detection) with MLD sensor and assembly instructions.

### OPTIONAL SERVICES

Assembly support, trainings and on-site service.

## Comparative measurements: Up to 28.1% Yield Increase

In the comparative measurement four different systems for generating solar energy were examined in solar park Rexingen in southern Germany. The aim of the two-year study was to determine the efficiency and higher yield of the photovoltaic modules compared to fixed tilt installed, astronomic tracked and tracking by MLD sensors of single- and dual-axis systems.

### CONDITIONS

The efficiency of solar panels depends on various factors such as temperature, air pressure and radiation values. So that the comparison measurements were carried out under the same conditions, all four systems were installed on the former landfill in Rexingen and equipped with the same modules and inverters.

Measurement of yield was determined for two years and was carried out under the following parameters and performance

Installation site	48° 26'50"North, 8° 39'48"East
Elevation N	569 meters
Irradiation	1,010 kWh/kWp (PVGIS)
Installed modules	Per unit 36 modules Sanyo HIP-215NKHE1
Nominal power	7.74 kWp
PV Inverter	Per unit one SMA SMC 8000TL
Nominal power	8.0 kW

### SYSTEM 1

Fixed tilt installation 30° south-facing



### SYSTEM 2

Single-axis DEGER tracking system with MLD sensor



### SYSTEM 3

Dual axis astronomical controlled

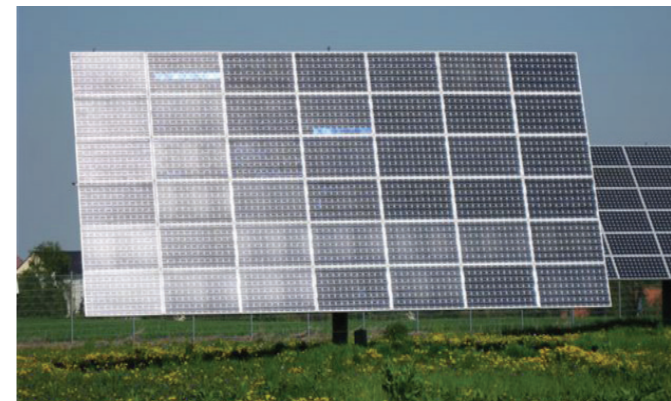

### SYSTEM 4

Dual-axis DEGER tracking system with MLD sensor



### ANALYSIS PROCEDURES

For the evaluation two different methods were used. The normalization method, in which all performance variables such as cable length, actual module output, inverter efficiency and other similar variables are taken into account. By the evaluation with the standard method the yield takes into account a theoretical consideration of the cable losses resulting directly from the measured data without further corrective calculation.



# Results

According to the one hundred percent availability of data in 2012 the following values are determined with the standard method:

COMPARATIVE MEASUREMENTS IN 2012 IN SOLAR PARK REXINGEN

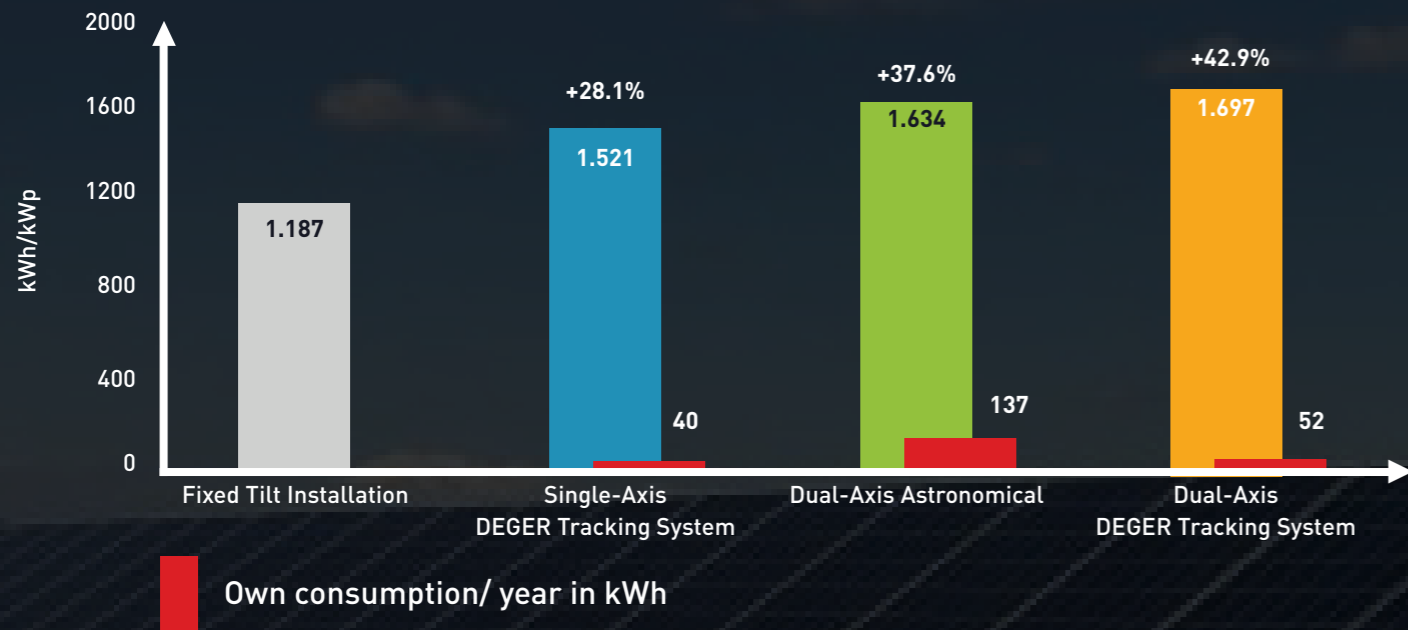

ADDITIONAL YIELD MONTHLY RESULTS IN 2012 COMPARED TO FIXED TILT SYSTEMS IN PERCENT

	JAN	FEB	MAR	APR	MAY	JUNE	JULY	AUG	SEP	OCT	NOV	DEC
single-axis DEGER tracking system	15.7%	15.2%	24.4%	19.8%	27.2%	23.1%	26.5%	29.5%	24.7%	18.8%	12.4%	19.8%
dual-axis astronomical	29.4%	-8.9%	33.5%	23.0%	36.8%	32.5%	34.4%	39.4%	29.0%	25.9%	22.6%	32.5%
dual-axis DEGER tracking system	52.5%	36.2%	35.9%	27.8%	38.6%	32.6%	38.5%	40.6%	33.8%	30.6%	29.5%	62.3%

## THE RESULT OF THE STUDY

- ◇ DEGER single axis tracking system are generating a 28.1% higher yield compared with static systems,
- ◇ DEGER dual axis tracking system are generating a 42.9% higher yield compared with static systems,
- ◇ DEGER tracking system are generating a 5.3% higher yield compared with astronomical controlled systems.
- ◇ DEGER tracking system have the lowest operating power consumption compared to the measured tracking systems in this study.
- ◇ During the winter, astronomically controlled units may not even outperform fixed systems when foggy or cloudy conditions are present. Only MLD technology senses that the diffuse irradiation is best captured with by presenting the most surface area possible.

ADDITIONAL YIELD MONTHLY RESULTS IN 2012 COMPARED TO FIXED TILT SYSTEMS

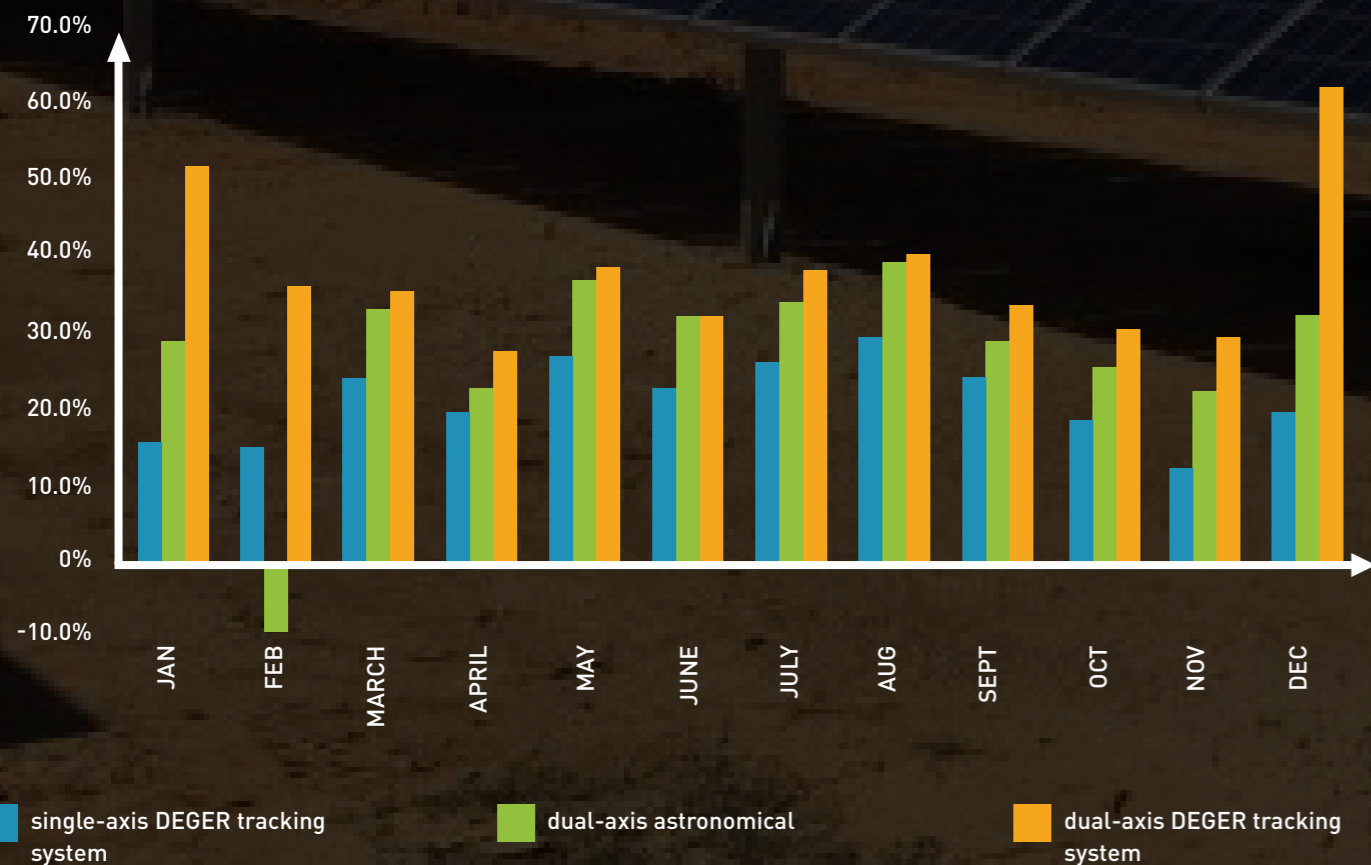

WE ARE AT YOUR SERVICE WORLDWIDE

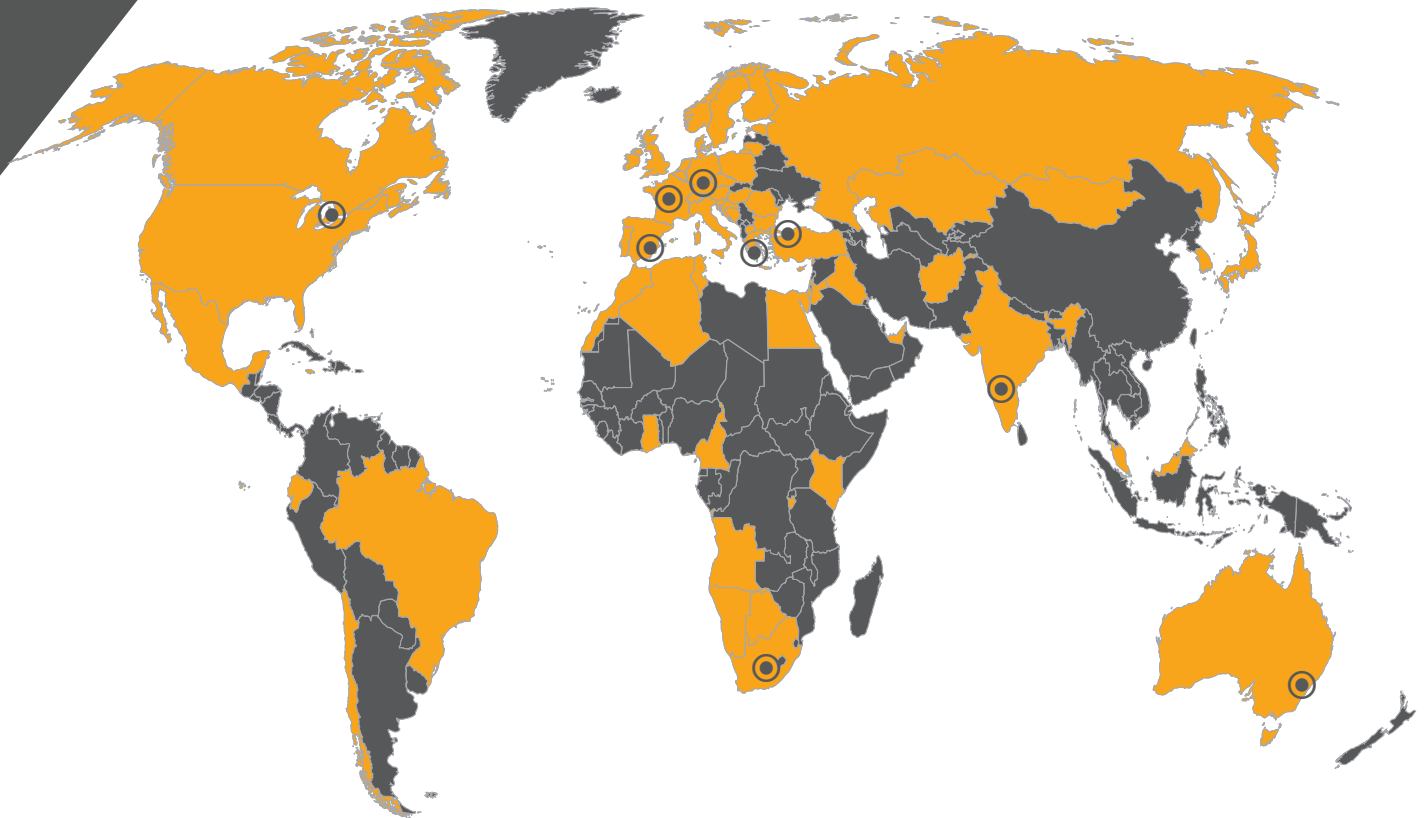

**DEGERenergie GmbH & Co. KG**

Hafnerstraße 50  
72131 Ofterdingen  
Germany

Phone: +49 7473 70218 48

E-Mail: [info@DEGERenergie.com](mailto:info@DEGERenergie.com)

 Sales and production locations

 Installed DEGER systems